



PRODUCT SPECIFICATIONS

Module No.: NTD-7.0T800480R111C

TFT(Thin-Film-Transistor) Color Liquid Crystal Display Module

General Specification

- 7.0 inch Diagonal
- 800xRGBx480 resolution
- 24 bit RGB interface
- LED Backlight (400cd/m²)
- 16.7 M colors
- 12:00 O'clock Optimal View
- **RoHS Compliant**

For Customer's Acceptance:

Approved By	Comment

From: NewTrend Display Technology Co., Ltd.

--

Outline Drawing

SYMBOL	REVISION		DATE
V0	First		

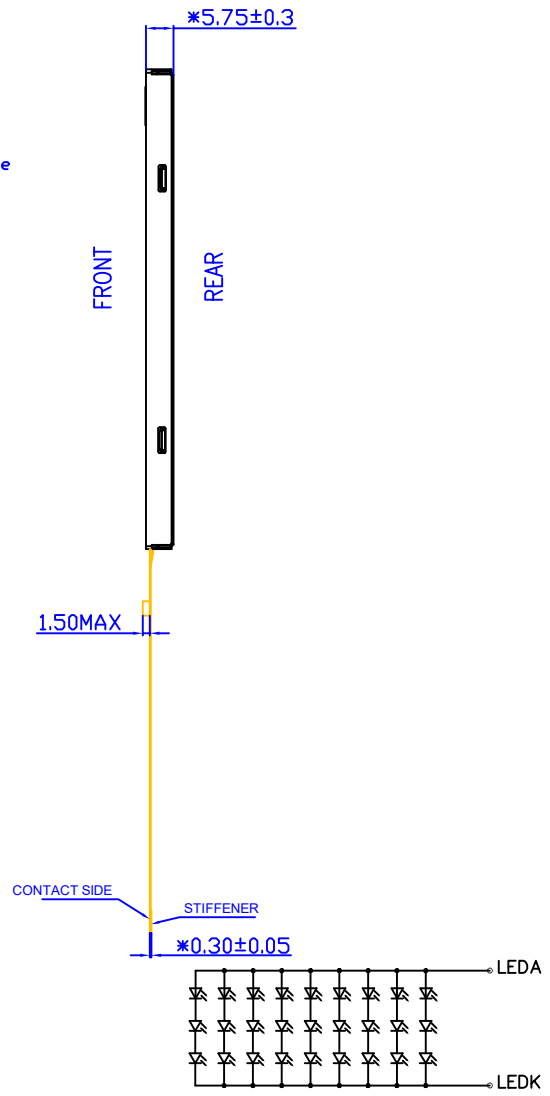
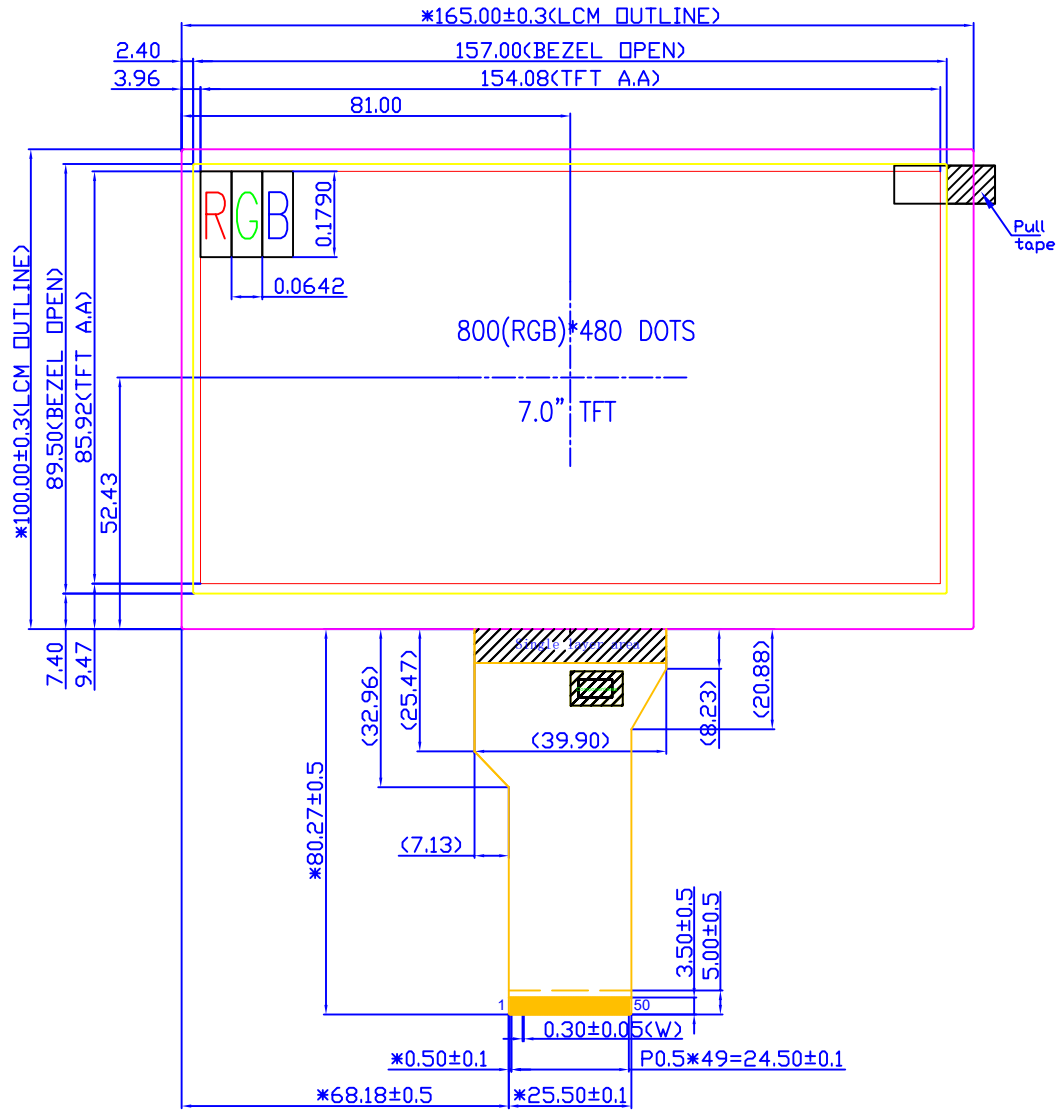

PIN NO.	SYMBOL
1	VLEDA
2	VLEDA
3	VLEDK
4	VLEDK
5	GND
6	VCOM
7	DVDD
8	MODE
9	DE
10	VS
11	HS
12~19	B7~B0
20~27	G7~G0
28~35	R7~R0
36	GND
37	DCLK
38	GND
39	L/R
40	U/D
41	VGH
42	VGL
43	AVDD
44	RESET
45	NC
46	VCOM
47	DITHB
48	GND
49	NC
50	NC

SCAN DIRECTION SETTING

L/R	U/D	Data Shifting
DVDD	GND	Left→Right, Up→Down(default)
GND	GND	Right→Left, Up→Down
DVDD	DVDD	Left→Right, Down→Up
GND	DVDD	Right→Left, Down→Up

- NOTES:
1. DISPLAY TYPE: 7.0" TFT, Transmissive, Normally White
 2. OPTIMUM VIEWING : 12:00
 3. Top: -20°C~+70°C, Tst: -30°C~+80°C
 4. TFT Interface :24-bit RGB Interace, DVDD=3.3±0.3V
 5. LCM Luminance:LED/400cd/m (TYP)² VLED:180mA,9.0±0.9V
 6. RoHS

UNLESS OTHERWISE SPECIFIED
Unit:mm
THIRD ANGLE PROJECTION:

NewTrend Display Technology

UNLESS OTHERWISE NOTED
TOLERANCES :±0.2mm

DRAWING_NO. NTD-7.0T800480R111C

SCALE	SHEET	DRAWN BY:	APPROVED BY:
1:1	1 OF 1		

Pin Description:

Pin No.	Symbol	Function Description	Remark
1~2	LEDA	LED backlight (Anode).	
3~4	LEDK	LED backlight (Cathode).	
5	GND	Ground.	
6	VCOM	No connection	
7	DVDD	Digital Power.	
8	MODE	DE/SYNC mode select. Normally pull high. H: DE mode. L: HSD/VSD mode.	
9	DE	Data enable input. Active high to enable the input data bus.	
10	VS	Frame sync signal	
11	HS	Line sync signal	
12~19	B7~B0	Blue Data Input	
20~27	G7~G0	Green Data Input	
28~35	R7~R0	Red Data Input	
36	GND	Ground	
37	DCLK	Clock Input	
38	GND	Ground	
39	L/R	Left or Right Display Control.	NOTE1
40	U/D	Up / Down Display Control.	NOTE1
41	VGH	Positive Power for TFT.	
42	VGL	Negative Power for TFT.	
43	AVDD	Analog Power.	
44	RESET	Global reset pin. Active low to enter reset state. Suggest to connecting with an RC reset circuit for stability. Normally pull high.(R=10KΩ, C=1μF)	
45	NC	No connection	
46	VCOM	No connection	
47	DIHTB	Dithering function enable control. (Normally pull high) DITHB="L", to enable internal dithering function. DITHB="H", to disable internal dithering function.	
48	GND	Ground.	
49~50	NC	No connection.	

【Note1】 L/R : left or right setting
U/D : up or down setting

L/R	U/D	Data shifting
DVDD	GND	Left → Right, Up → Down(default)
GND	GND	Right → Left, Up → Down
DVDD	DVDD	Left → Right, Down → Up
GND	DVDD	Right → Left, Down → Up

Definition of scanning direction:

Definition of scanning direction:

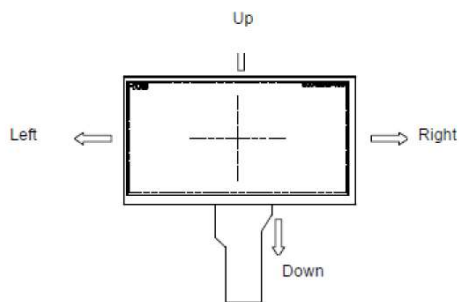

DC Electrical Characteristics

Item	Symbol	Condition	Min.	Typ.	Max.	Unit
Operating Temperature Range	Top	Absolute Max	-20	-	+70	°C
Storage Temperature Range	T _{ST}	Absolute Max	-30	-	+80	°C
Digital Supply Voltage	V _{DD}	-	3.0	3.3	3.6	V
Analog Supply Voltage	AVDD	-	10.2	10.4	10.6	V
Gate On Voltage	V _{GH}	-	15.3	16.0	16.7	V
Gate Off Voltage	V _{GL}	-	-7.7	-7.0	-6.3	V
Input logic high voltage	V _{IH}	-	0.7*DVDD	-	DVDD	V
Input logic low voltage	V _{IL}	-	GND	-	0.3*DVDD	V

Item	Symbol	Condition	Min.	Typ.	Max.	Unit
Backlight Supply Voltage	V _f	Top=25°C I _f =180mA	8.1	9.0	9.9	V
Backlight Supply Current	I _f		-	180		mA
Backlight Lifetime	-	Top=25°C I _f =180mA		50000		Hrs

*Backlight lifetime is rated as Hours until half-brightness, under normal operating conditions. The LED of the backlight is driven by current drain, drive voltage is for reference only. Drive voltage must be selected to ensure backlight current drain is below MAX level stated.

Optical Characteristics

Item	Symbol	Condition	Min.	Typ.	Max.	Unit	
Operating Viewing Angles	Top	-	CR≥10	40	50	-	Deg
	Bottom	-		60	70	-	
	Left	-		60	70	-	
	Right	-		60	70	-	
Contrast Ratio	CR	Center	400	500	-	-	
Luminance	L _v		350	400		cd/m ²	
Response Time	Tr+Tf			25	50	ms	
Chromaticity	Red	X _R	-	TYP-0.05	TYP+0.05	-	
		Y _R					
	Green	X _G	-				
		Y _G					
	Blue	X _B	-				
		Y _B					
	White	X _W	-				
Y _W		-					

Note (1) Measurement Setup: The LCD module should be stabilized at given temp. 25°C for 15 minutes to avoid abrupt temperature change during measuring. In order to stabilize the luminance, the measurement should be executed after lighting backlight for 15 minutes in a windless room.

Power Sequence

a. Power on:

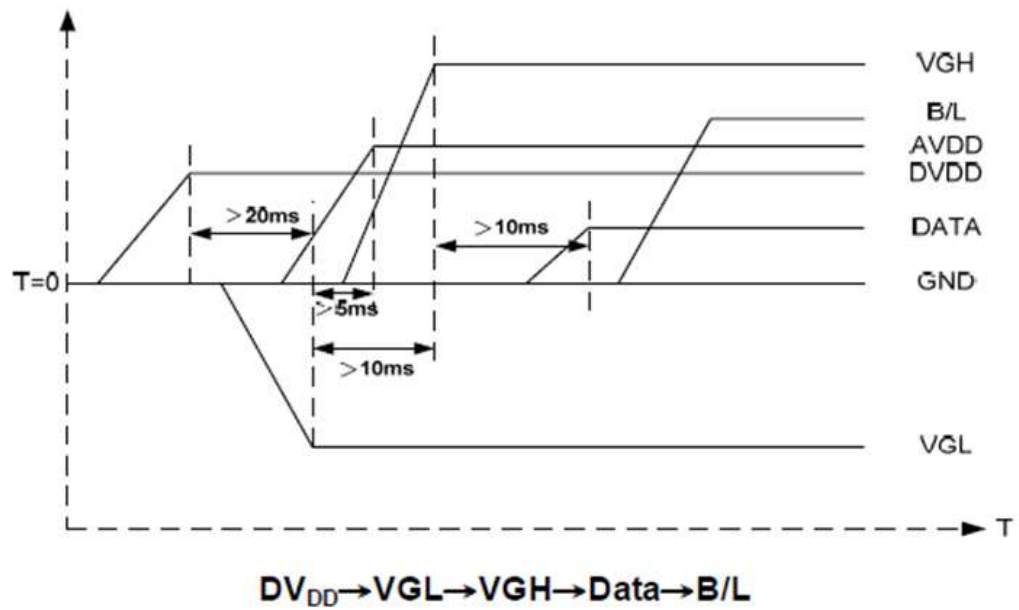

b. Power off:

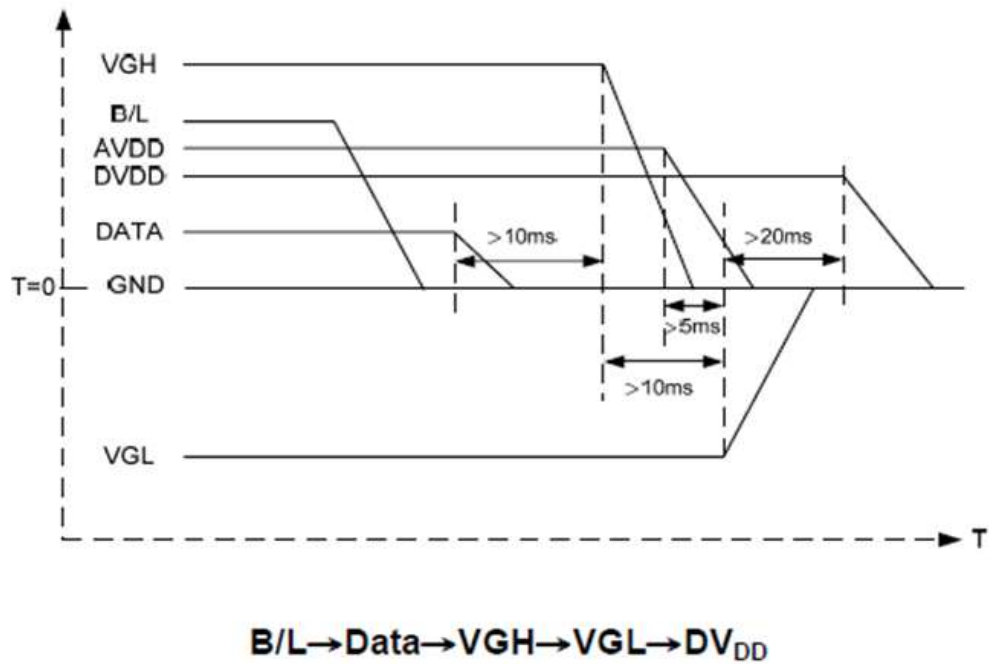

Note: Data include R0~R7, B0~B7, GO~G7, U/D, L/R, DCLK, HS, VS, DE.

AC Electrical Characteristics

Item	Symbol	Values			Unit	Remark
		Min.	Typ.	Max.		
HS setup time	T_{hst}	8	-	-	ns	
HS hold time	T_{hhd}	8	-	-	ns	
VS setup time	T_{vst}	8	-	-	ns	
VS hold time	T_{vhd}	8	-	-	ns	
Data setup time	T_{dsu}	8	-	-	ns	
Data hole time	T_{dhd}	8	-	-	ns	
DE setup time	T_{esu}	8	-	-	ns	
DE hole time	T_{ehd}	8	-	-	ns	
DV _{DD} Power On Slew rate	T_{POR}	-	-	20	ms	From 0 to 90% DV _{DD}
RESET pulse width	T_{Rst}	1	-	-	ms	
DCLK cycle time	T_{coh}	20	-	-	ns	
DCLK pulse duty	T_{cwh}	40	50	60	%	

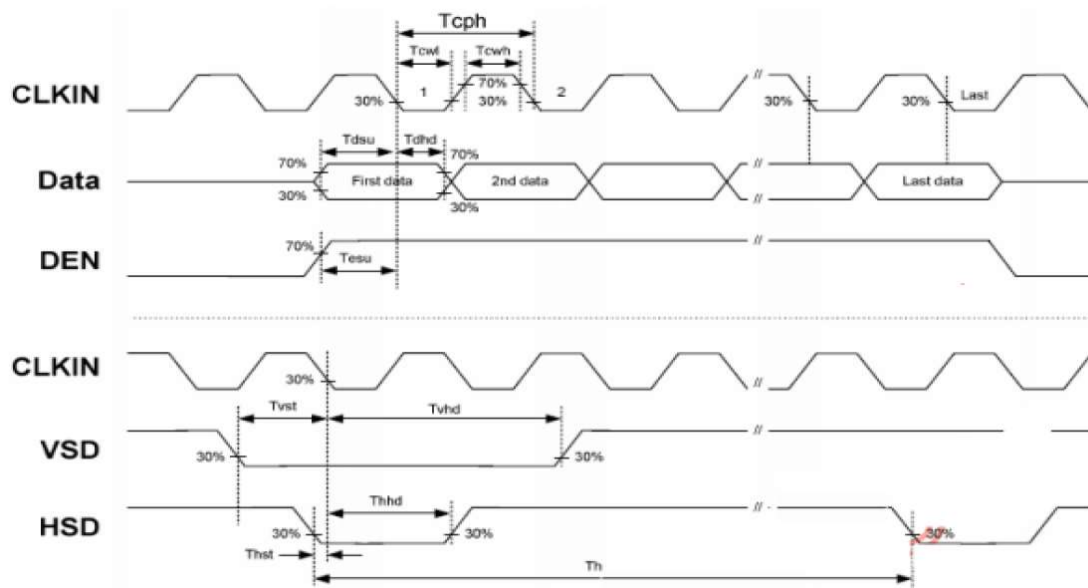

Date Input Format

Horizontal input timing diagram



Vertical input timing diagram

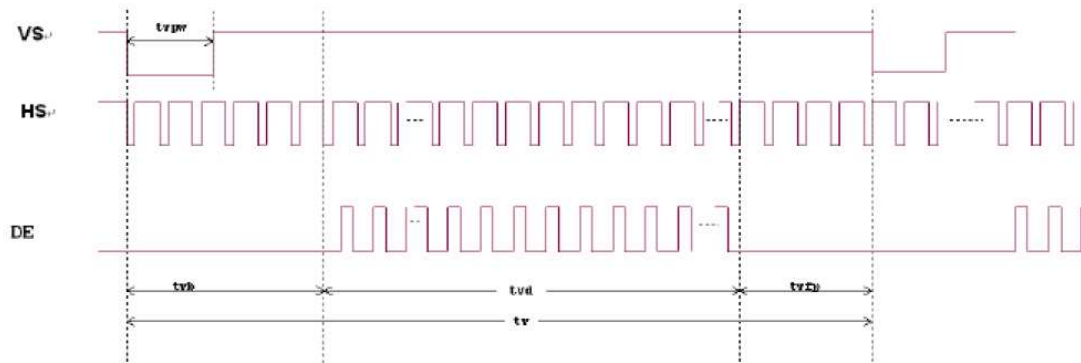

Timing

Item	Symbol	Values			Unit	Remark
		Min.	Typ.	Max.		
Horizontal Display Area	thd	-	800	-	DCLK	
DCLK Frequency	fclk	26.4	33.3	46.8	MHz	
One Horizontal Line	th	862	1056	1200	DCLK	
HS pulse width	thpw	1	-	40	DCLK	
HS Blanking	thb	46	46	46	DCLK	
HS Front Porch	thfp	16	210	354	DCLK	

Item	Symbol	Values			Unit	Remark
		Min.	Typ.	Max.		
Vertical Display Area	tvd	-	480	-	TH	
VS period time	tv	510	525	650	TH	
VS pulse width	tvpw	1	-	20	TH	
VS Blanking	tvb	23	23	23	TH	
VS Front Porch	tvfp	7	22	147	TH	

2. Storage precautions

2.1 When storing the LCD modules, avoid exposure to direct sunlight or to the light of fluorescent lamps.

2.2 The LCD modules should be stored under the storage temperature range. If the LCD modules will be stored for a long time, the recommend condition is:

Temperature : 10°C ~ 40°C

Relatively humidity: ≤60%

2.3 The LCD modules should be stored in the room without acid, alkali and harmful gas.

3. The LCD modules should be no falling and violent shocking during transportation, and also should avoid excessive press, water, damp and sunshine.